

# FUJIFILM

FUJI MEDICAL DRY LASER IMAGER

# DRYPIX

# 4000

Outstanding performance, remarkable efficiency and superb quality satisfy your medical imaging needs



DRYPIX 4000 shown with optional 4-bin film sorter

# Compact dimensions hide generous potential

The latest addition to the DRYPIX family, new DRYPIX 4000 is the ideal imager for medium-size hospitals, combining proven reliability and convenience with remarkable operating efficiency, all in a compact body. Features including unrivalled image quality, networkability, backup security, and low cost of ownership make the DRYPIX 4000 a welcome addition to any hospital department.



Image Intelligence is a set of sophisticated image processing technologies incorporated in the DRYPIX 4000 that consistently optimize displayed digital images. They include Image Expression Technology tools to enhance image appearance, and Diagnostic Support Processing tools to increase diagnostic accuracy.

## DRYPIX 4000

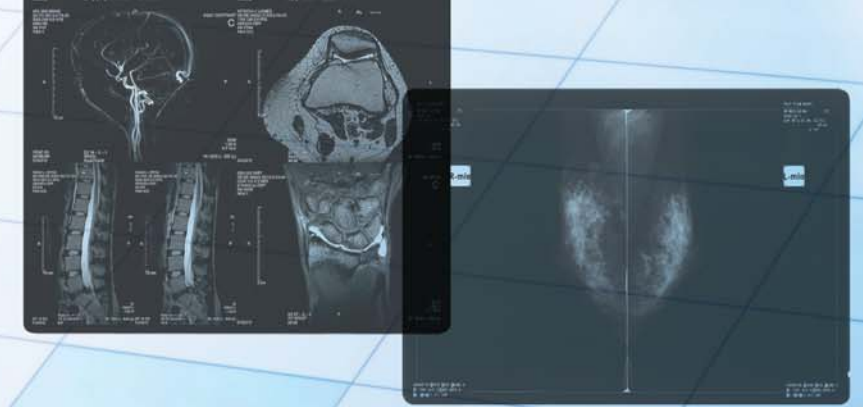

## High-quality images for more versatility

Backed up by Fujifilm's extensive experience in dry imaging, the combination of DRYPIX 4000 and Fujifilm dry imaging film ensures consistent delivery of superior image quality to satisfy the varying demands of multi-departmental hospitals.

### Enhanced Diagnostic Capabilities

Fujifilm's advanced photo-thermographic technology with barcode reader-activated Automatic Film Density Calibration and DI-HL film combine to produce clear, stable images with low minimum density, wide density range and neutral image tone that are indistinguishable from those produced by conventional wet processing films.

### High Resolution & High Maximum Density

Offering 50-micron high-resolution capability and 3.6 maximum density, DRYPIX 4000 is ideal for Women's Health Centers and dedicated Full Field Digital Mammography departments.

## Compact with high efficiency

DRYPIX 4000's compact dimensions allow maximum freedom of location within the medical facility. Belying its small size, throughput is extremely high with absolutely no compromise on image quality. An additional advantage is DRYPIX 4000's extremely quick cold-start time of 15 minutes maximum.

### High throughput

DRYPIX 4000's dry laser imaging system enables a high throughput of 110 to 160 films per hour (depending on film size) with premium image quality.

### Universal film trays

DRYPIX 4000 can be configured with up to two film trays, allowing printing with multiple film sizes.

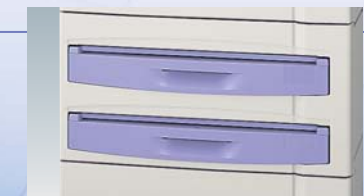

### Optional 4-bin film sorter

The top-mounted 4-bin film sorter increases workflow in small centralized departments without enlarging DRYPIX 4000's compact footprint.

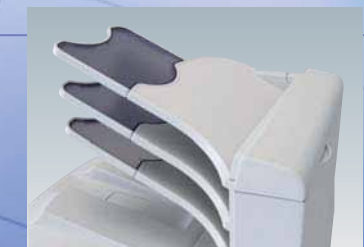

## ECO-DRY SYSTEM

DRYPIX's ECO-DRY System is environmentally friendly, from films to processing. DRYPIX medical films employ unique aqueous solvents that are free from unpleasant odors and create neutral colored images so crisp, they're indistinguishable from those printed on wet halide film. Additional ECO-DRY advantages include our development of new liquid-coating technology, which obviates the need for harmful organic solvents in the thermal development of light-sensitive materials.

## Dry Laser Imaging System

DRYPIX 4000's dry laser imaging process utilizes interpolation to magnify or reduce medical diagnostic images read from modalities, generating film image outputs in a variety of formats. Exposing the film surface to a modulating laser in accordance with the inputted data produces ultra-precise images while significantly reducing throughput time. Cost efficiency benefits from no messy chemicals to handle or dispose of.

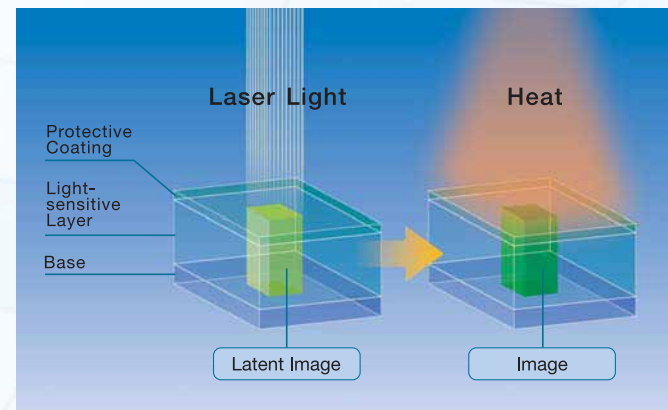

## Advanced Variable Response (A-VR) Spline Interpolation

Fujifilm's A-VR automatically detects and distinguishes between image data and alphanumeric characters, ensuring clear, sharp reproduction of both types, even at high magnification. Benefits include easier, faster, more accurate diagnosis.

(A-VR) Flowchart

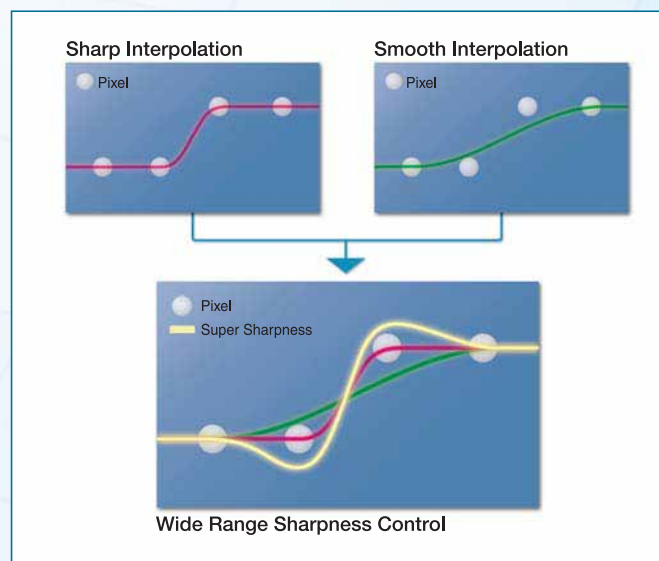
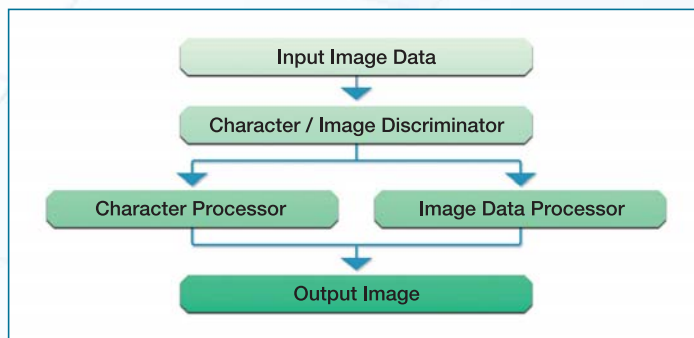

## More Measures For Better Images



### Automatic Self-calibration

DRYPIX 4000 prints a 24-step grayscale pattern to film, and then accurately gauges its density, allowing precise and subtle image adjustments. A barcode reader in the film drawer automatically initiates this Auto Film Density Correction (FDC) function when a new batch of film is loaded.

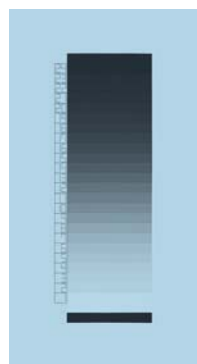

### SAR (Smooth Curve Arranging)

Smooth Curve Arranging on DRYPIX 4000 not only offers the most suitable image tones for modalities such as CT and MRI, but also allows adjustment of the tones to best match the diagnostic needs of individual patients. What's more, LUT also carries information on a wide range of modalities from different manufacturers to enable precise matching of image tone to specific modality.

## Easy Operation

DRYPIX 4000's newly developed touch-panel operation screen with icon-based interface simplifies operation and reduces operator error. All operations, from film loading to processing, can be carried out in daylight room conditions.

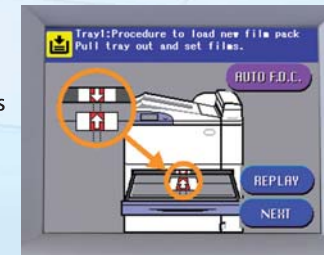

### Signal Lamp

Unique to DRYPIX 4000, a large, easy-to-see Signal Lamp flashes green when DRYPIX 4000 is warming up, changing to a steady green when ready to print. The light can also be programmed to flash or glow amber to indicate various error conditions.



## Networkability

DRYPIX 4000's built-in high-speed DICOM Print Server ensures fast, error-free connection, for instantaneous communication with any DICOM Print-compliant modality on the network. The robust overall design with high throughput, backup security, multiple film sizes and sorting capacity make DRYPIX 4000 the ideal centralized imager, maximizing the efficiency of your multi-modality network.

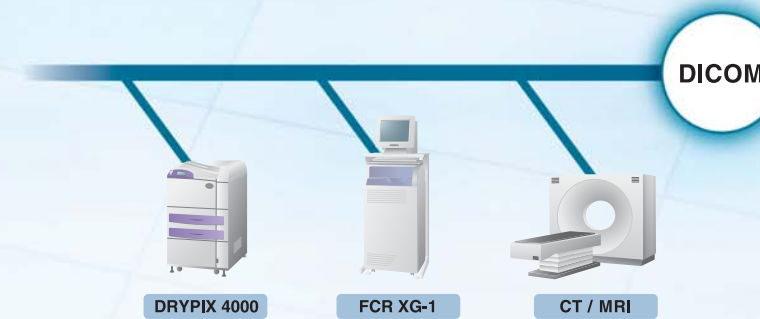

### DRYPIX STATION

DRYPIX STATION has two capabilities: functioning in combination with DRYPIX LINK while connecting to the worklist; and auto-routing DICOM images for back-up and fail-safe purposes.

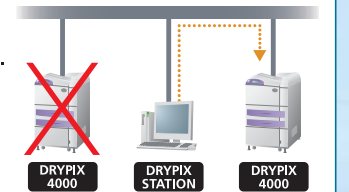

### DRYPIX LINK

DRYPIX LINK connects to non-DICOM modalities, sending image data to DRYPIX 4000 through the DICOM network. Optional DRYPIX STATION enhances network capability by integrating worklist information with input image data.



## DI-HL / DI-HLc

Contributing to DRYPIX 4000's consistently clear, low-minimum-density images is new DI-HL/DI-HLc film, whose neutral color tone produces images comparable to those from conventional wet processing. For the DRYPIX 4000, the new film is available in four sizes (14" x 17", 25.7 x 36.4cm, 10" x 12" or 8" x 10") in either clear base or blue base properties.



35 x 43cm (14" x 17")

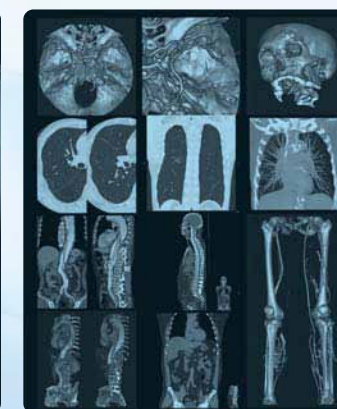

35 x 43cm (14" x 17")

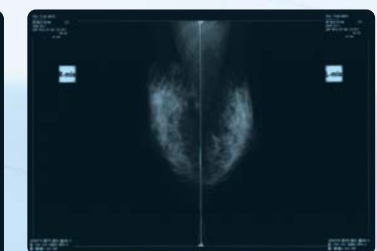

25.7 x 36.4cm (10" x 14")



20.3 x 25.4cm (8" x 10")

# Fuji Medical Dry Laser Imager DRYPIX 4000 Specifications

## Basic Specifications

Recording method:	Laser exposure thermal development system
Applicable film:	Fuji Medical Dry Imaging Film DI-HL (blue base)/DI-HLc (clear base) 35x43cm (14"x17"), 25.7x36.4cm, 25.4x30.5cm (10"x12"), 20.3x25.4cm (8"x10")
Film loading:	Daylight film loading
Film trays:	Up to 2 trays*
Processing capacity:	Approx. 110 films/hour (14"x17"), approx. 160 films/hour (25.7x36.4cm, 10"x12", 8"x10")
Time required for first output:	Approx. 85 seconds (14"x17" film size for test printing)
Grayscale resolution:	14 bits
Pixel size:	100/50 microns is selectable for all sizes. **
Input channels:	One DICOM network channel
Image memory:	Standard 256MB (maximum 512MB)
Density adjustment:	Automatic density correction
Optional sorter bins:	4 bins (including standard film tray)

## Physical Characteristics

External dimensions ( W x D x H ) :	600 x 585 x 1040mm (1 tray type without sorter) / 600 x 585 x 1340mm (1 tray type with sorter option)
Weight (with one tray) :	130kg (287lbs) without sorter
Power supply:	AC100-120V±10%, Single phase, 50-60Hz, 12A AC200-240V±10%, Single phase, 50-60Hz, 6A

## Operating Environment

Temperature:	15-30°C
Humidity:	40-70% RH (at 15°C) to 15-70% RH (at 30°C) (no dew condensation)

\* Configurable based on user requirements. \*\* High resolution is for mammography use, requiring a 256MB add-on memory.

**Note:** Specifications are subject to change without notice. Consult your local Fujifilm representative for details of models and types.

## Dimensions

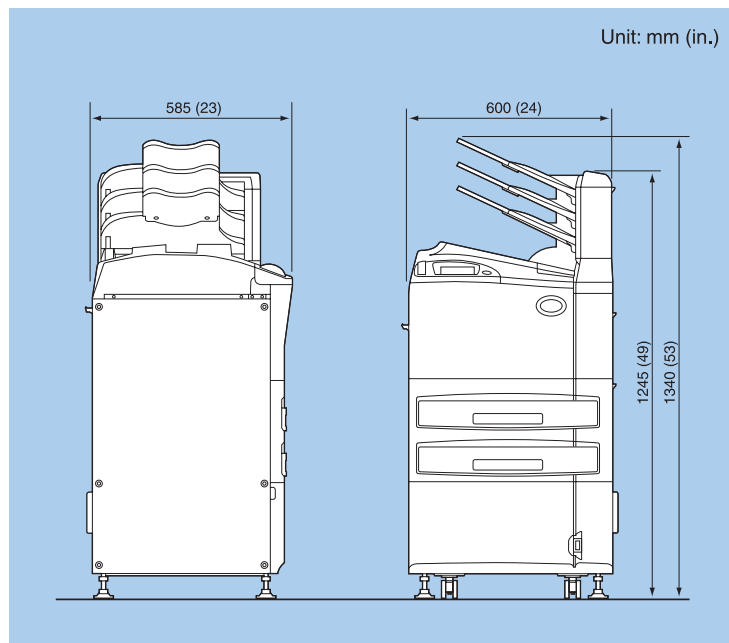

### DRYPIX 4000 Mobile Application (optional)

DRYPIX 4000 offers a special mobile option kit designed to withstand the shocks and vibrations typically experienced in mobile imaging facilities.



**FUJIFILM**

FUJIFILM Corporation

26-30, NISHIAZABU 2-CHOME, MINATO-KU, TOKYO 106-8620, JAPAN

### Dealer Information

A Walsh Imaging, Inc.  
55 Cannonball Road  
Pompton Lakes, NJ 07442

Phone 1-866-429-9729

Web [www.awalshimaging.com](http://www.awalshimaging.com)

Ref. No. XB